

Accessories for Installation BGJ Series Explosion-proof Connectors

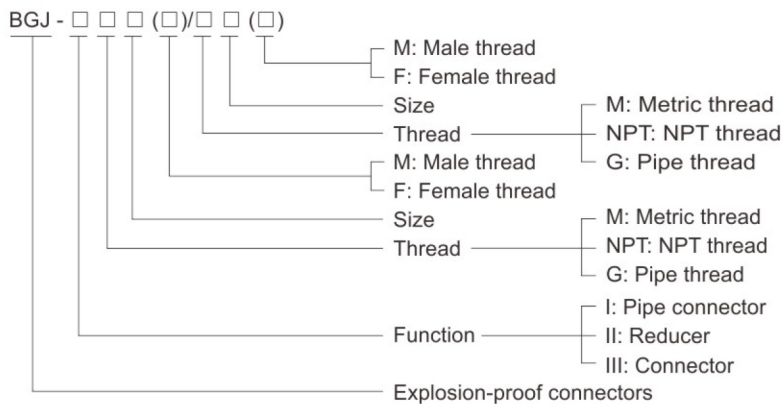

- ◆ Explosion protection to
 - CENELEC
 - IEC
- ◆ Can be used in
 - Zone 1 and Zone 2
 - Zone 21 and Zone 22
- ◆ Available in nickel plated brass, stainless steel or galvanized carbon steel.

Catalogue number logic



Technical data

Explosion-proof connectors

BGJ-□□□(□)/□□(□)

Explosion protection

Global (IECEX)
Gas and dust

IECEX CNEX 18.0038U
Ex db IIC Gb
Ex eb IIC Gb
Ex tb IIIC Db

Europe (ATEX)
Gas and dust

CNEX 18 ATEX 0030U
⊕ II 2 G Ex db IIC Gb
⊕ II 2 G Ex eb IIC Gb
⊕ II 2 D Ex tb IIIC Db

Certificates

Conformity to standards

EN 60079-0, EN 60079-1, EN 60079-7, EN 60079-31
IEC 60079-0, IEC 60079-1, IEC 60079-7, IEC 60079-31

Material

Degree of protection

Ambient temperature

Type

Function

Nickel plated brass, stainless steel or galvanized carbon steel
IP66
-60°C~+100°C
F/F, M/F or M/M
Pipe connector, reducer, connector

Zones 1&2; 21&22

Accessories for Installation

BGJ Series Explosion-proof Connectors

Selection table

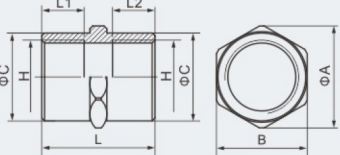
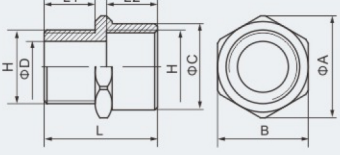
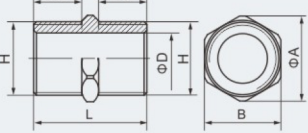
| Version | Female thread "H" | | | Dimensions (mm) | | | | | | | Ordering code | Weight (kg) |
|---|-------------------|--------|--------|-----------------|-----|-----|-----|----|----|----|---------------|-------------|
| | Metric | NPT | G | A | B | C | D | L | L1 | L2 | | |
|  BGJ-I□□(F)/□□(F) | M20 | 1/2" | 1/2" | 30 | 27 | 25 | | 34 | 15 | 15 | 703001 | 0.10 |
| | M25 | 3/4" | 3/4" | 35 | 32 | 31 | | 34 | 15 | 15 | 703002 | 0.10 |
| | M32 | 1" | 1" | 42 | 38 | 37 | | 44 | 19 | 19 | 703003 | 0.15 |
| | M40 | 1 1/4" | 1 1/4" | 54 | 49 | 46 | | 44 | 19 | 19 | 703004 | 0.25 |
| | M50 | 1 1/2" | 1 1/2" | 60 | 55 | 54 | | 44 | 19 | 19 | 703005 | 0.25 |
| | M63 | 2" | 2" | 72 | 68 | 67 | | 46 | 19 | 19 | 703006 | 0.35 |
| | M75 | 2 1/2" | 2 1/2" | 88 | 83 | 81 | | 46 | 19 | 19 | 703007 | 0.50 |
| | M90 | 3" | 3" | 105 | 100 | 98 | | 46 | 19 | 19 | 703008 | 0.65 |
| | M110 | 4" | 4" | 130 | 125 | 123 | | 46 | 19 | 19 | 703009 | 1.00 |
|  BGJ-I□□(M)/□□(F) | M20 | 1/2" | 1/2" | 30 | 27 | 25 | 15 | 36 | 15 | 17 | 703010 | 0.10 |
| | M25 | 3/4" | 3/4" | 35 | 32 | 31 | 18 | 36 | 15 | 17 | 703011 | 0.10 |
| | M32 | 1" | 1" | 42 | 38 | 37 | 25 | 44 | 19 | 20 | 703012 | 0.15 |
| | M40 | 1 1/4" | 1 1/4" | 54 | 49 | 46 | 32 | 44 | 19 | 20 | 703013 | 0.20 |
| | M50 | 1 1/2" | 1 1/2" | 60 | 55 | 54 | 38 | 44 | 19 | 20 | 703014 | 0.25 |
| | M63 | 2" | 2" | 72 | 68 | 67 | 50 | 46 | 19 | 21 | 703015 | 0.35 |
| | M75 | 2 1/2" | 2 1/2" | 88 | 83 | 81 | 65 | 46 | 19 | 21 | 703016 | 0.50 |
| | M90 | 3" | 3" | 105 | 100 | 98 | 75 | 46 | 19 | 21 | 703017 | 0.65 |
| | M110 | 4" | 4" | 130 | 125 | 123 | 100 | 46 | 19 | 21 | 703018 | 1.00 |
|  BGJ-I□□(M)/□□(M) | M20 | 1/2" | 1/2" | 30 | 27 | | 15 | 36 | 15 | 15 | 703019 | 0.05 |
| | M25 | 3/4" | 3/4" | 35 | 32 | | 18 | 36 | 15 | 15 | 703020 | 0.10 |
| | M32 | 1" | 1" | 42 | 38 | | 25 | 46 | 19 | 19 | 703021 | 0.15 |
| | M40 | 1 1/4" | 1 1/4" | 50 | 46 | | 32 | 46 | 19 | 19 | 703022 | 0.25 |
| | M50 | 1 1/2" | 1 1/2" | 60 | 55 | | 38 | 46 | 19 | 19 | 703023 | 0.25 |
| | M63 | 2" | 2" | 72 | 68 | | 50 | 46 | 19 | 19 | 703024 | 0.35 |
| | M75 | 2 1/2" | 2 1/2" | 88 | 83 | | 65 | 46 | 19 | 19 | 703025 | 0.50 |
| | M90 | 3" | 3" | 100 | 95 | | 75 | 46 | 19 | 19 | 703026 | 0.65 |
| | M110 | 4" | 4" | 127 | 122 | | 100 | 46 | 19 | 19 | 703027 | 1.00 |



Note: 1. Standard material is galvanized carbon steel. Nickel plated brass or stainless steel is optional.

Above weight is based upon galvanized carbon steel.

2. Metric threads are 1.5mm pitch as standard, others thread pitch can be customized, please specify when ordering.

Accessories for Installation

BGJ Series Explosion-proof Connectors

Selection table

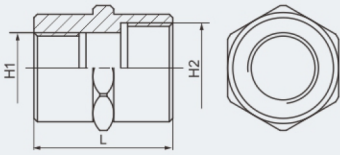
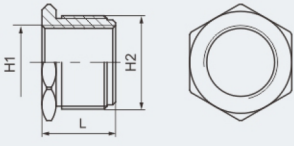
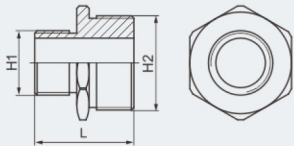
| Version | Female thread "H1" | | | Female thread "H2" | | | Dimensions (mm) L | Ordering code | Weight (kg) |
|--|--------------------|--------|--------|--------------------|--------|--------|-------------------------|------------------|----------------|
| | Metric | NPT | G | Metric | NPT | G | | | |
|  BGJ-II□□(F)/□□(F) | M20 | 1/2" | 1/2" | M25 | 3/4" | 3/4" | 36 | 703028 | 0.10 |
| | M25 | 3/4" | 3/4" | M32 | 1" | 1" | 38 | 703029 | 0.15 |
| | M32 | 1" | 1" | M40 | 1 1/4" | 1 1/4" | 44 | 703030 | 0.25 |
| | M40 | 1 1/4" | 1 1/4" | M50 | 1 1/2" | 1 1/2" | 44 | 703031 | 0.30 |
| | M50 | 1 1/2" | 1 1/2" | M63 | 2" | 2" | 44 | 703032 | 0.35 |
| | M63 | 2" | 2" | M75 | 2 1/2" | 2 1/2" | 44 | 703033 | 0.50 |
| | M75 | 2 1/2" | 2 1/2" | M90 | 3" | 3" | 44 | 703034 | 0.65 |
| | M90 | 3" | 3" | M110 | 4" | 4" | 44 | 703035 | 1.00 |
|  BGJ-II□□(M)/□□(F) | M20 | 1/2" | 1/2" | M25 | 3/4" | 3/4" | 21 | 703036 | 0.05 |
| | M25 | 3/4" | 3/4" | M32 | 1" | 1" | 25 | 703037 | 0.10 |
| | M32 | 1" | 1" | M40 | 1 1/4" | 1 1/4" | 25 | 703038 | 0.25 |
| | M40 | 1 1/4" | 1 1/4" | M50 | 1 1/2" | 1 1/2" | 25 | 703039 | 0.45 |
| | M50 | 1 1/2" | 1 1/2" | M63 | 2" | 2" | 25 | 703040 | 0.60 |
| | M63 | 2" | 2" | M75 | 2 1/2" | 2 1/2" | 25 | 703041 | 0.75 |
| | M75 | 2 1/2" | 2 1/2" | M90 | 3" | 3" | 25 | 703042 | 0.90 |
| | M90 | 3" | 3" | M110 | 4" | 4" | 25 | 703043 | 1.20 |
|  BGJ-II□□(M)/□□(M) | M20 | 1/2" | 1/2" | M25 | 3/4" | 3/4" | 36 | 703044 | 0.10 |
| | M25 | 3/4" | 3/4" | M32 | 1" | 1" | 40 | 703045 | 0.15 |
| | M32 | 1" | 1" | M40 | 1 1/4" | 1 1/4" | 46 | 703046 | 0.25 |
| | M40 | 1 1/4" | 1 1/4" | M50 | 1 1/2" | 1 1/2" | 46 | 703047 | 0.25 |
| | M50 | 1 1/2" | 1 1/2" | M63 | 2" | 2" | 46 | 703048 | 0.35 |
| | M63 | 2" | 2" | M75 | 2 1/2" | 2 1/2" | 46 | 703049 | 0.50 |
| | M75 | 2 1/2" | 2 1/2" | M90 | 3" | 3" | 46 | 703050 | 0.65 |
| | M90 | 3" | 3" | M110 | 4" | 4" | 46 | 703051 | 1.00 |

Note: 1. Standard material is galvanized carbon steel. Nickel plated brass or stainless steel is optional.

Above weight is based upon galvanized carbon steel.

2. Metric threads are 1.5mm pitch as standard, others thread pitch can be customized, please specify when ordering.

Accessories for Installation

BGJ Series Explosion-proof Connectors

Selection table

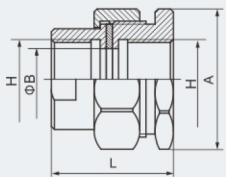
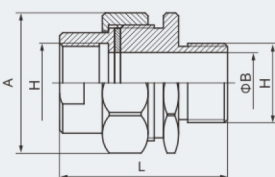
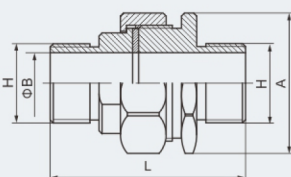
| Version | Female thread "H" | | | Dimensions (mm) | | | Ordering code | Weight (kg) |
|--|-------------------|--------|--------|-----------------|-----|----|---------------|-------------|
| | Metric | NPT | G | A | B | L | | |
|  BGJ- III□□(F)/□□(F) | M20 | 1/2" | 1/2" | 37 | 15 | 40 | 703052 | 0.15 |
| | M25 | 3/4" | 3/4" | 42 | 20 | 40 | 703053 | 0.25 |
| | M32 | 1" | 1" | 48 | 25 | 46 | 703054 | 0.35 |
| | M40 | 1 1/4" | 1 1/4" | 65 | 32 | 46 | 703055 | 0.50 |
| | M50 | 1 1/2" | 1 1/2" | 70 | 38 | 46 | 703056 | 0.50 |
| | M63 | 2" | 2" | 85 | 50 | 52 | 703057 | 0.85 |
| | M75 | 2 1/2" | 2 1/2" | 108 | 65 | 52 | 703058 | 1.25 |
| | M90 | 3" | 3" | 115 | 76 | 57 | 703059 | 1.70 |
| | M110 | 4" | 4" | 145 | 100 | 57 | 703060 | 2.20 |
|  BGJ- III□□(M)/□□(F) | M20 | 1/2" | 1/2" | 37 | 15 | 55 | 703061 | 0.20 |
| | M25 | 3/4" | 3/4" | 42 | 20 | 55 | 703062 | 0.30 |
| | M32 | 1" | 1" | 48 | 25 | 64 | 703063 | 0.45 |
| | M40 | 1 1/4" | 1 1/4" | 65 | 32 | 64 | 703064 | 0.60 |
| | M50 | 1 1/2" | 1 1/2" | 70 | 38 | 64 | 703065 | 0.65 |
| | M63 | 2" | 2" | 85 | 50 | 73 | 703066 | 1.05 |
| | M75 | 2 1/2" | 2 1/2" | 110 | 102 | 73 | 703067 | 1.45 |
| | M90 | 3" | 3" | 115 | 110 | 81 | 703068 | 1.55 |
| | M110 | 4" | 4" | 145 | 140 | 81 | 703069 | 2.00 |
|  BGJ- III□□(M)/□□(M) | M20 | 1/2" | 1/2" | 37 | 15 | 64 | 703070 | 0.20 |
| | M25 | 3/4" | 3/4" | 42 | 20 | 64 | 703071 | 0.30 |
| | M32 | 1" | 1" | 48 | 25 | 74 | 703072 | 0.45 |
| | M40 | 1 1/4" | 1 1/4" | 65 | 32 | 74 | 703073 | 0.70 |
| | M50 | 1 1/2" | 1 1/2" | 70 | 38 | 74 | 703074 | 0.75 |
| | M63 | 2" | 2" | 85 | 50 | 84 | 703075 | 1.20 |
| | M75 | 2 1/2" | 2 1/2" | 110 | 102 | 84 | 703076 | 1.60 |
| | M90 | 3" | 3" | 115 | 110 | 94 | 703077 | 2.05 |
| | M110 | 4" | 4" | 145 | 140 | 94 | 703078 | 2.55 |



Note: 1. Standard material is galvanized carbon steel. Nickel plated brass or stainless steel is optional.

Above weight is based upon galvanized carbon steel.

2. Metric threads are 1.5mm pitch as standard, others thread pitch can be customized, please specify when ordering.